

HOUSING	OPERATING DISTANCE	MOUNTING	✓ Long sensing range ✓ Outstanding accuracy and temperature stability ✓ Resolution in μm range	✓ Exceptional price-performance ratio ✓ Current or voltage output ✓ IP67
M30	20 mm	Quasi-embeddable		

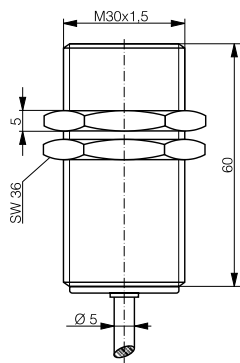

DW-AD-509-M30

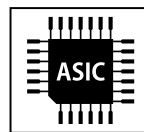
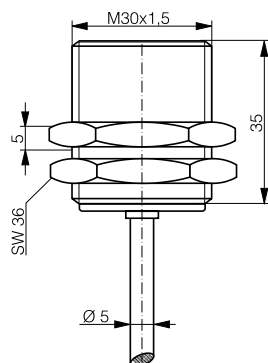

DW-AD-509-M30-120

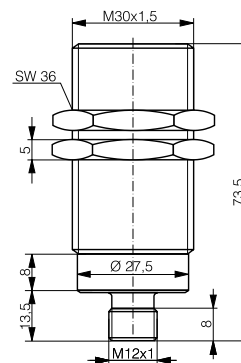

DW-AS-509-M30-002

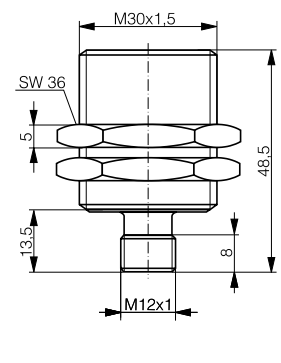

DW-AS-509-M30-120

DETECTION DATA		INTERFACE	
Sensing distance (S_d)	20 mm	IO-Link	✗
Repeat accuracy*	± 0.02 mm	MTTF (@40°C)	546 y
Static resolution** (@0.67· S_d)	≤ 0.41 μm		
Dynamic resolution* (@0.67· S_d)	≤ 1.55 μm		
Temperature drift on output signal***	$\leq \pm 10\%$		
Standard target	60 x 60 x 1 mm ³ , FE360		

*Measured under 3 σ confidence level (99.7%) at 0.67 S_d , constant temperature and constant voltage supply.

**Static resolution is measured filtering the signal at 20 Hz. Dynamic resolution is measured filtering the signal at 1 kHz.

***Over time a temperature drift of up to 10% can occur on the sensor, so regular calibration is recommended, depending on the application.

ELECTRICAL DATA		MECHANICAL DATA	
Supply voltage range (U_B)	10...30 VDC	Mounting	Quasi-embeddable
Residual ripple	$\leq 20\%$ U_B	Housing material	Chrome-plated brass
Power consumption (no-load)	≤ 12 mA	Sensing face material	PBTP
Max. load at voltage output	≤ 10 mA	Max tightening torque	70 Nm
Max. load at current output	1k Ω ($U_B=10V$) / 5k Ω ($U_B=30V$)	Ambient operating temperature	-25...+70°C
Bandwidth	200 Hz	Enclosure rating	IP67
Time delay before availability	20 ms	Weight (cable / connector)	see page 2
Recovery time	50 ms	Shock and vibration	IEC 60947-5-7
Warm-up time (temperature stability)	5 min		
Short-circuit protection	✓		
Voltage reversal protection	✓		
Cable length max.	≤ 300 m		

Note: all data measured according to IEC 60947-5-2 standard with $U_B = 20 \dots 30VDC$, $T_A = 23^\circ C \pm 5^\circ C$.

CORRECTION FACTORS

Steel FE 360	1	Copper	0.28	Aluminum	0.32	Brass	0.4	Stainless S. V2A 1 / 2 mm	0.7
--------------	---	--------	------	----------	------	-------	-----	---------------------------	-----

Note: the operating distance of the sensor must be multiplied by the correction factor of the material. For example, the operating distance on Aluminum is $S_{n,Al} = S_n \times CF_{Al}$. In case of embeddable mounting, the distance is multiplied by the additional correction factor of the support, thus $S_{n,Al} = S_n \times CF_{Al} \times CF_{emb,Al}$.

INSTALLATION CONDITIONS

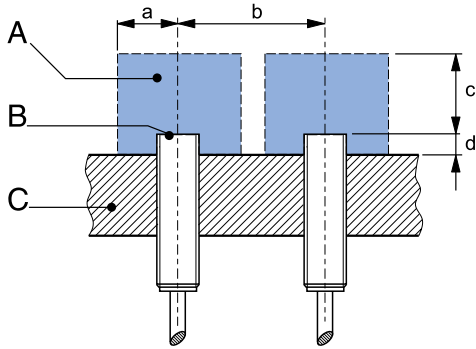

A : metal free zone	a : 35 mm
B : sensing face	b : 80 mm
C : support	c : 60 mm
	d : steel 4 mm

Note: additional installation information can be found in the glossary of the Contrinex General Catalog.

RESPONSE DIAGRAM

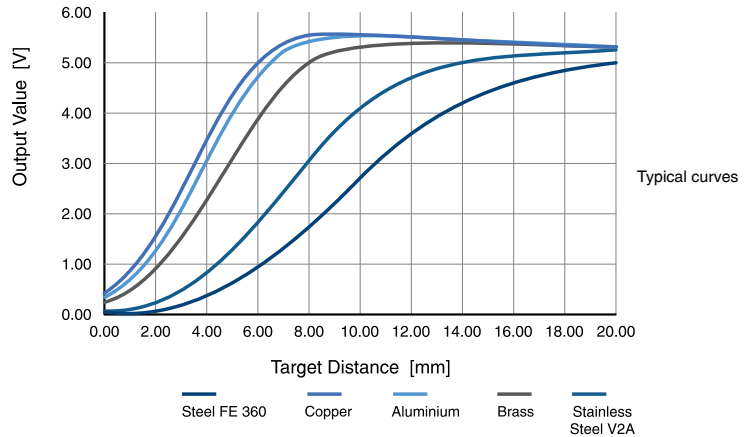

Output voltage	s = 0	0 V / -0.0 +0.2 V	Output current	s = 0	1 mA ± 0.2 mA
	s = $S_d/2$	2.6 V ± 0.2 V		s = $S_d/2$	3.1 mA ± 0.2 mA
s = S_d	5.0 V ± 0.2 V	s = S_d	5 mA ± 0.2 mA		
s > S_d	5...6 V ± 0.2 V	s > S_d	5...5.75 mA ± 0.2 mA		

WIRING DIAGRAM

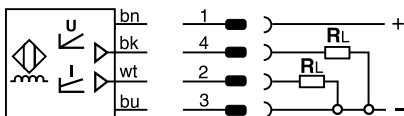

PIN ASSIGNMENT

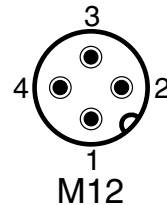

AVAILABLE TYPES

Part number	Part reference	Connection	Output on pin 2 / wh	Output on pin 4 / bk	Weight
330-020-415	DW-AD-509-M30	PUR, 2 m, 4 wire	1...5 mA	0...5 V	215 g
330-020-416	DW-AD-509-M30-120	PUR, 2 m, 4 wire	1...5 mA	0...5 V	190 g
330-020-444	DW-AS-509-M30-002	M12 4-pin	1...5 mA	0...5 V	155 g
330-020-445	DW-AS-509-M30-120	M12 4-pin	1...5 mA	0...5 V	135 g

Note: part reference may include additional suffix to indicate a revision version or special version. Further information is available on request.

Product warranty is contingent upon professional use and proper installation of the product in applications for which the product was intended for, namely systems of automated manufacturing processes (factory automation). The warranty does not cover products that were modified, that have expired or that were subjected to physical, environmental, chemical or electrical stress beyond their original design specifications. This product is not a safety component as defined by IEC-61508, ISO 13489 or other international safety standards. The manufacturer does not guarantee product performance in specific applications and does not warrant specifications in case of significant recurring temperature cycling. Terms of delivery and rights to change design reserved. All rights reserved.